

Non-Programmed Rapid Fire Mod for PS3

Created by: GBlaster

Nearly \$200 to replace three broken controllers and uncountable amount of parts later; this tutorial is created in order to aid you in creating a Non-programmed rapid-fire mod for your PS3 safely.

This was created for non-profit purposes that way you would not have to pay other people to have pre-programmed controllers built or for turbo controllers.

In order to create this you need to have a somewhat basic understanding of soldering.

Please review this tutorial before attempting it.

I am not responsible for any damage caused to your Playstation 3 controller or Playstation 3 system.

Tools:

- Solder Gun
- Solder
- Wire (I believe I used 30 AWG)
- Wire Cutter
- Tape (Recommended)
- Hot Glue Gun + Hot Glue (Recommended)

Supplies:

1) 555 Timer IC (I recommend using the TLC Low Power kind because the regular one is known to cause problems while charging or if the battery is full)- \$1.69

2) 10k ohm resistor (R_1)(Brown Black Orange Gold) - \$0.69

3) 56k ohm resistor (R_2)(5 Pack)(Green Blue Orange Gold) - \$0.69

4) 1.0 uF Electrolytic Capacitor (C_1) - \$1.19

5) .01 uF Polyester Film Capacitor (C_2) - \$1.49

6) NPN Transistor (15 pack) - \$2.59

7) Momentary Switch - \$2.69

Price: \$11.03

Total + Tax: \$12.00

I recommend you buy the 100-pack of resistors because it can be a little difficult to find the 56k resistors otherwise. - \$6.49 (Has both 10k and 56k resistors)



Preparation: Take apart the controller

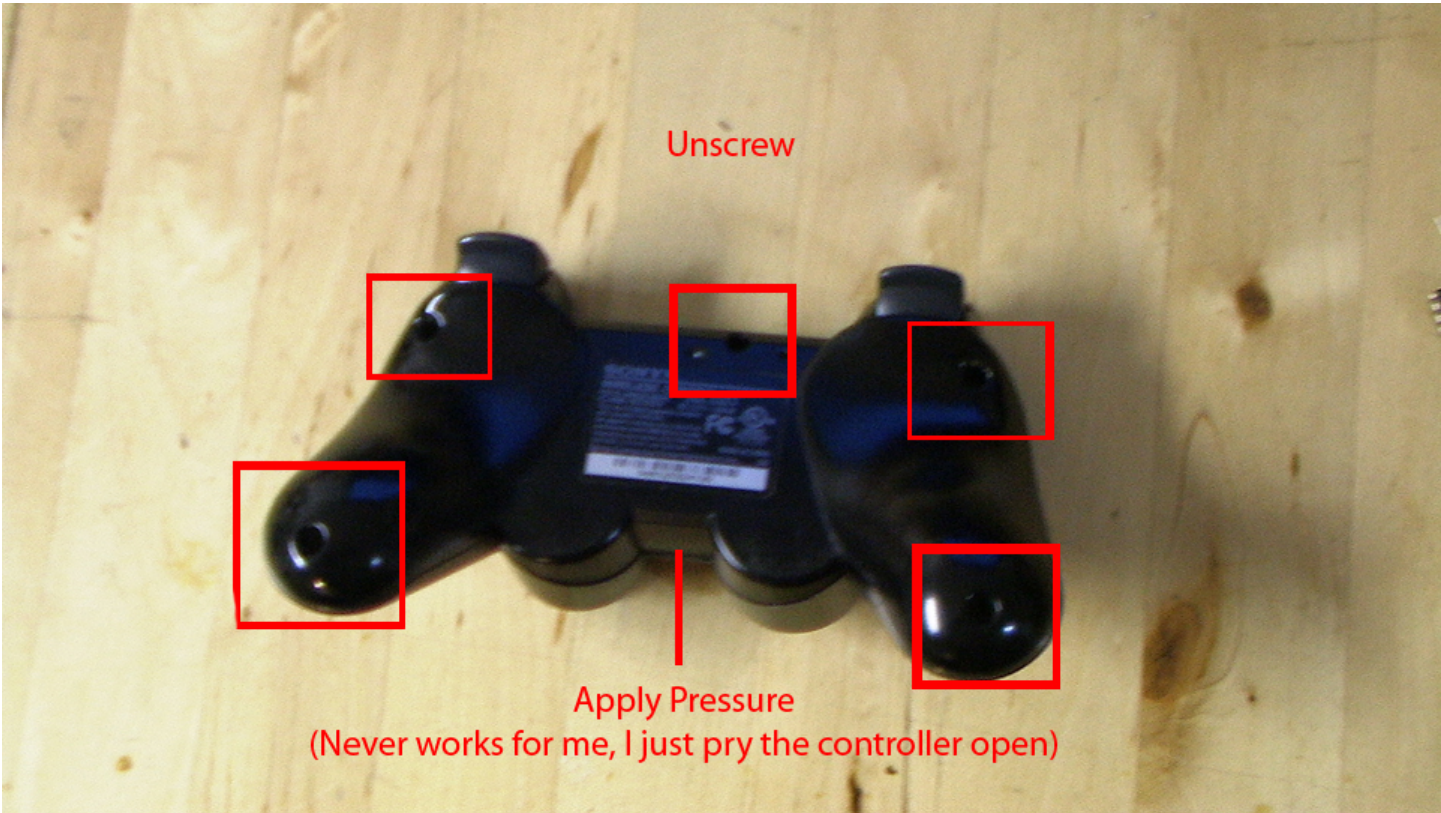

Step 1) Place timer upside-down and connect 7+8 using R₁ (10k)

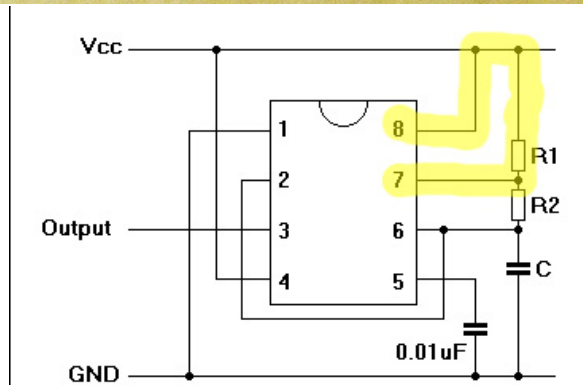
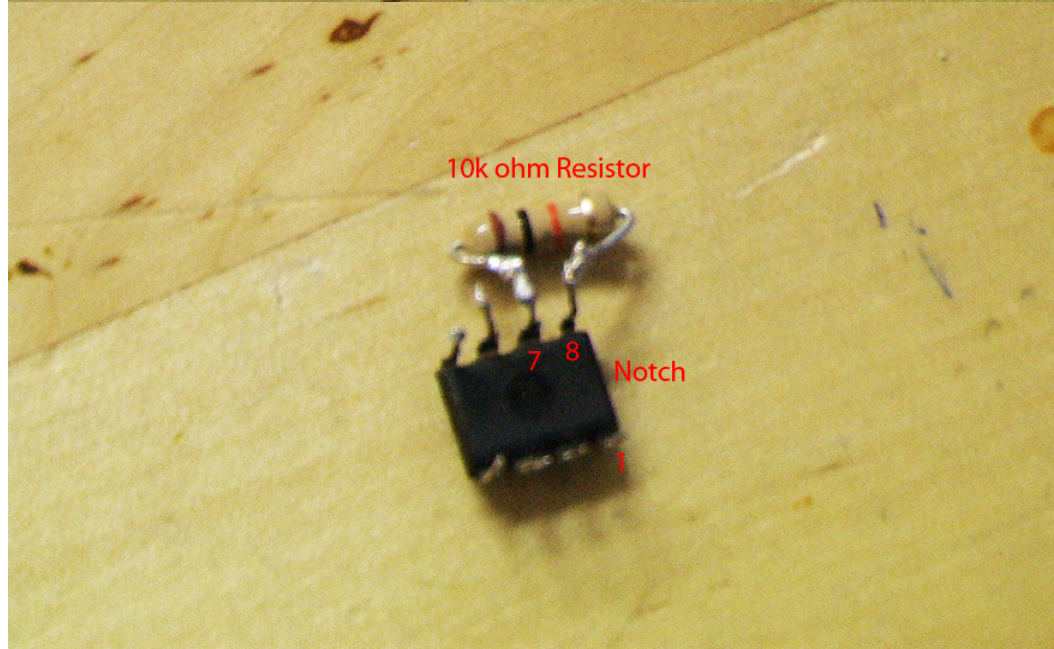
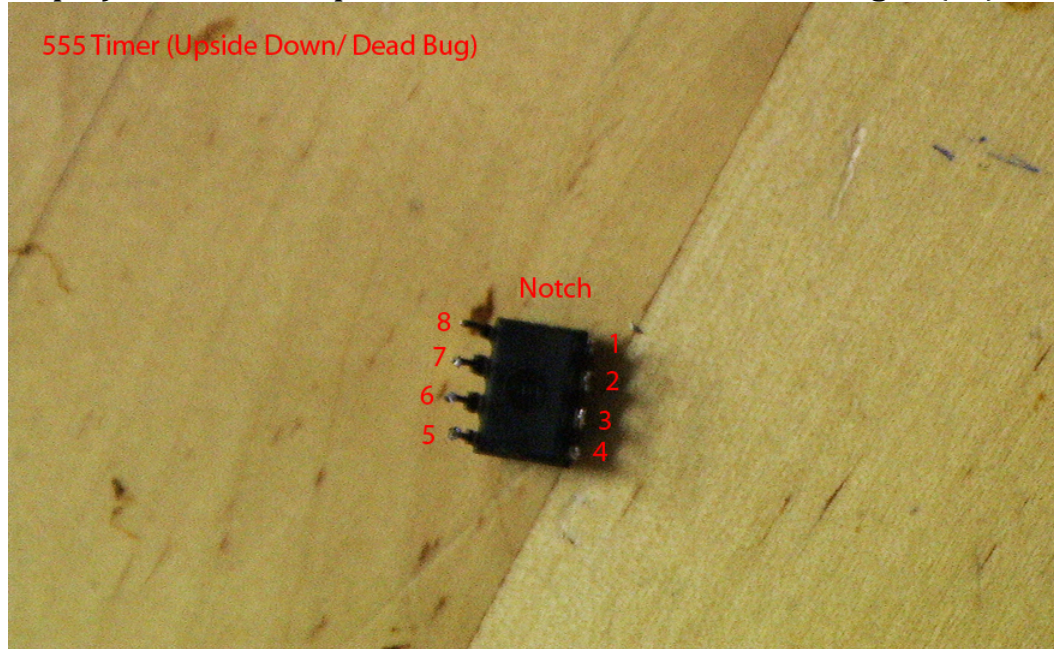

Step 2) Connect 6+7 using R₂ (56k)

Forgot a picture for Step 2.

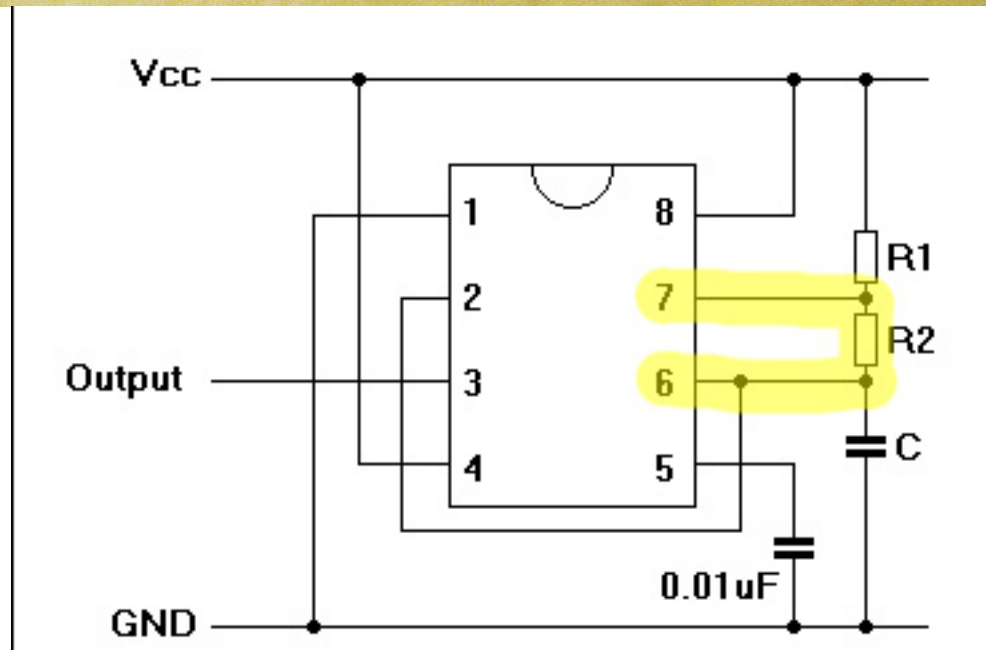
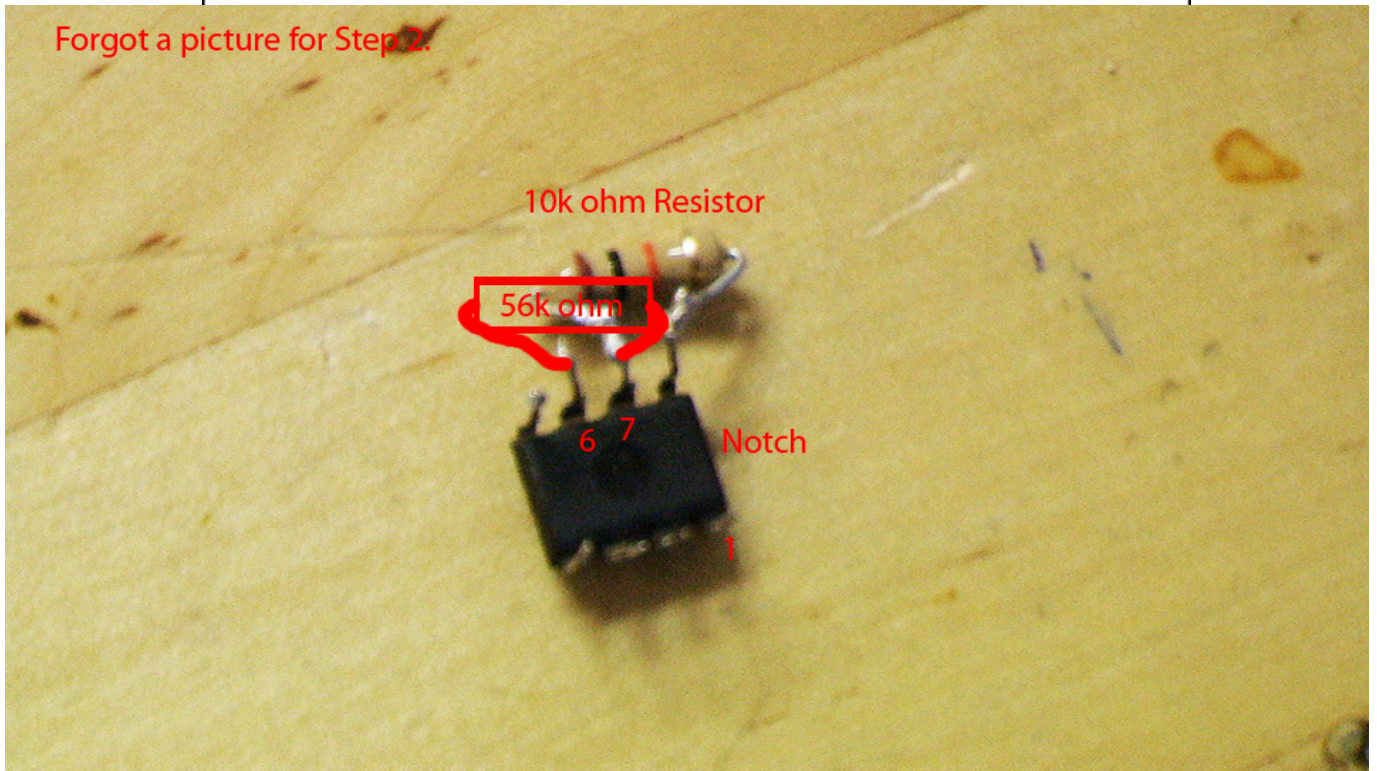

Step 3) Connect 6+1 with C_1 (1 μ F)

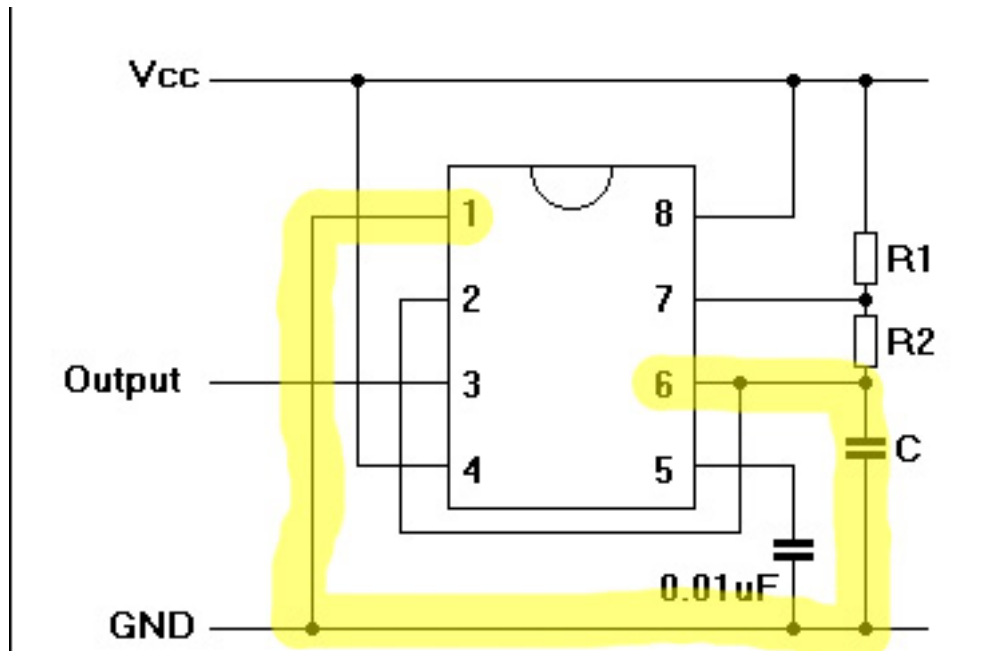

Step 4) Connect 5+1 with C₂ (.01uF)

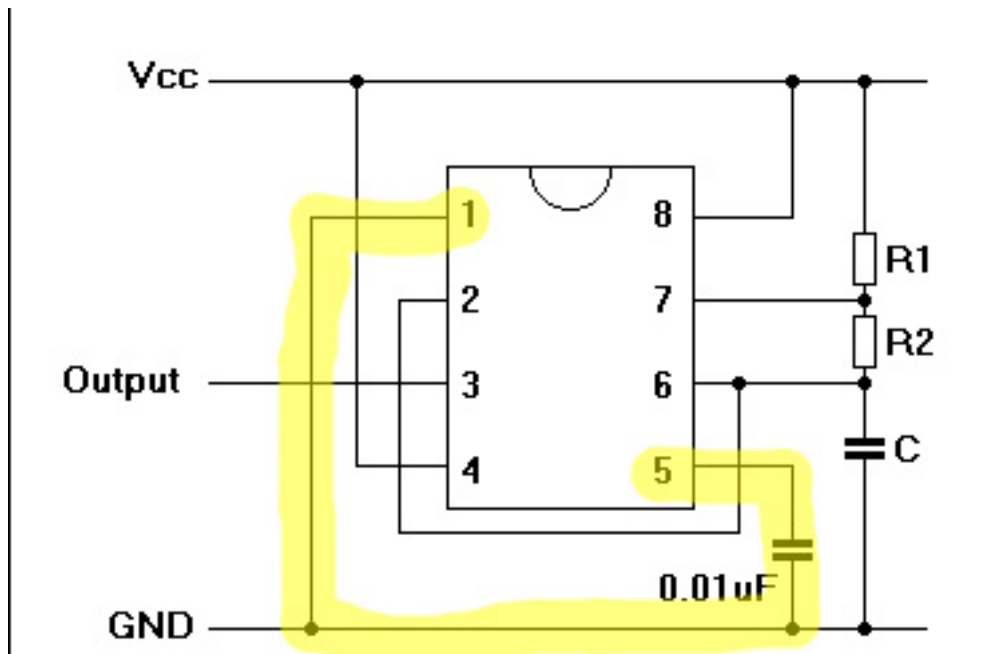

Step 5) Connect 4+8 with a small wire

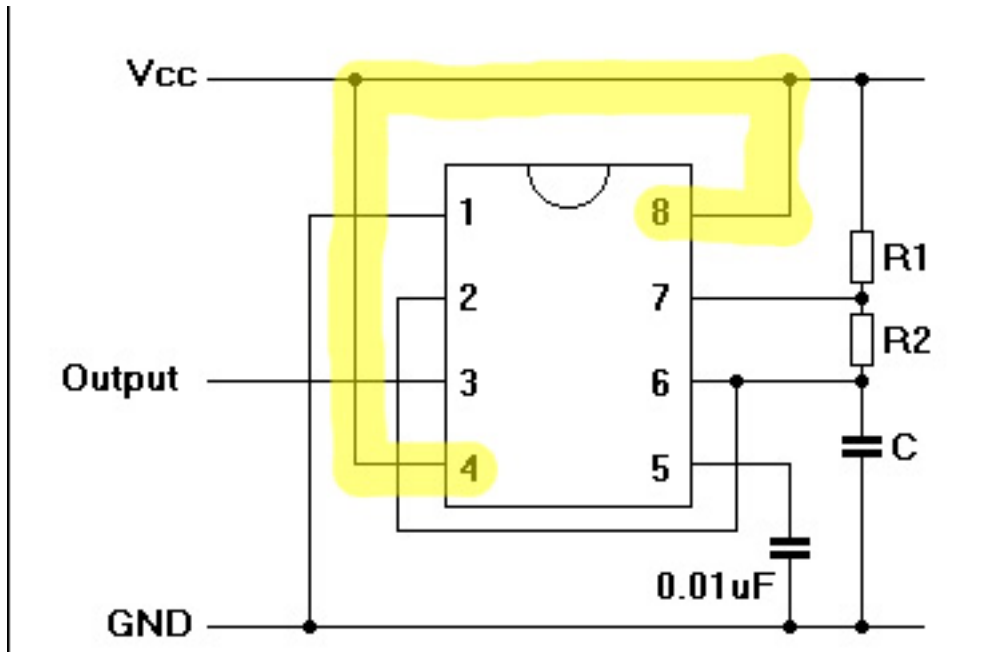
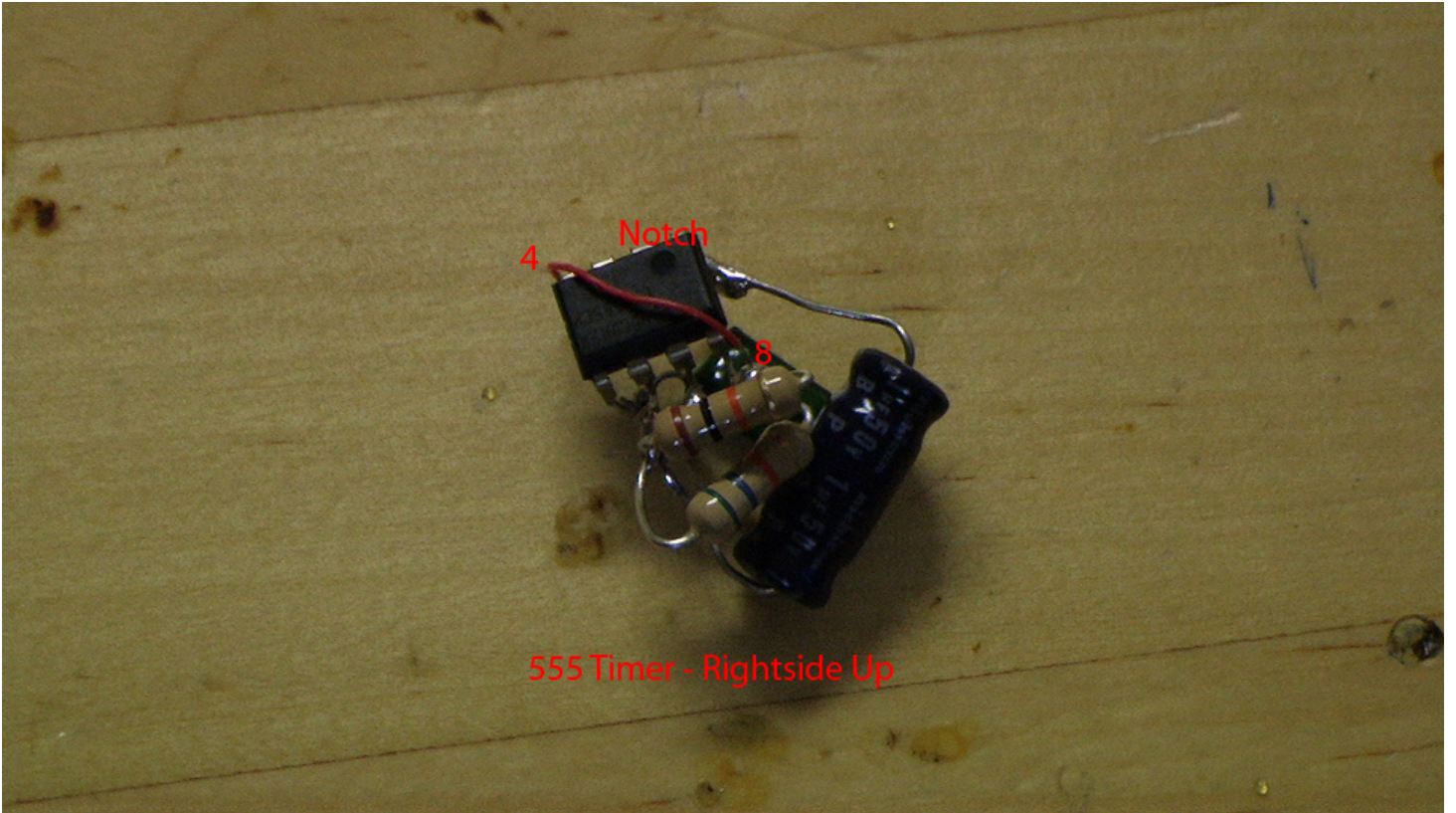

Step 6) Connect 2+6 with a small wire

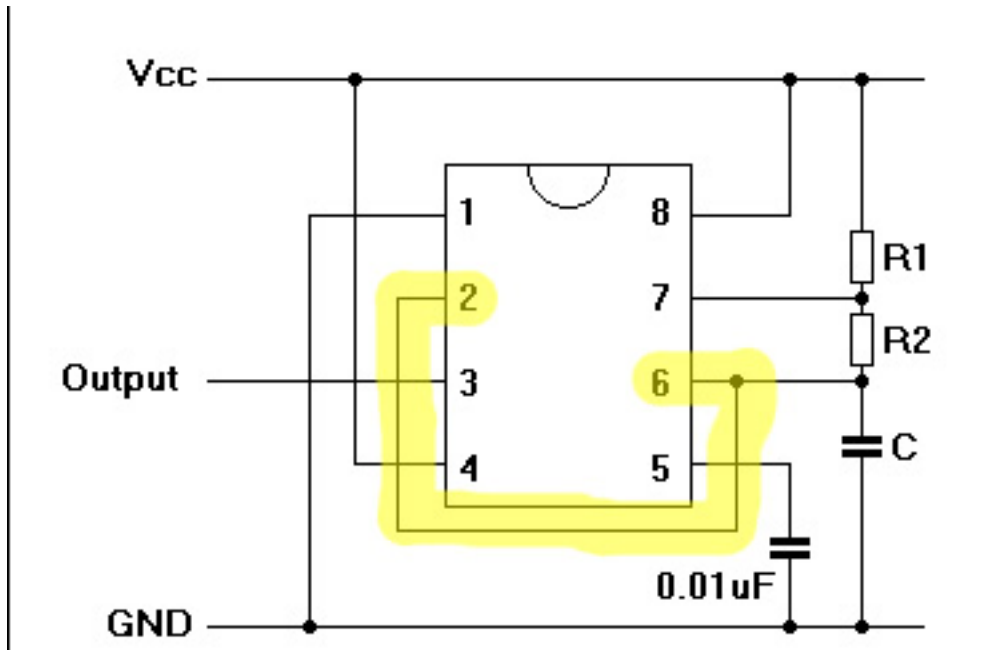
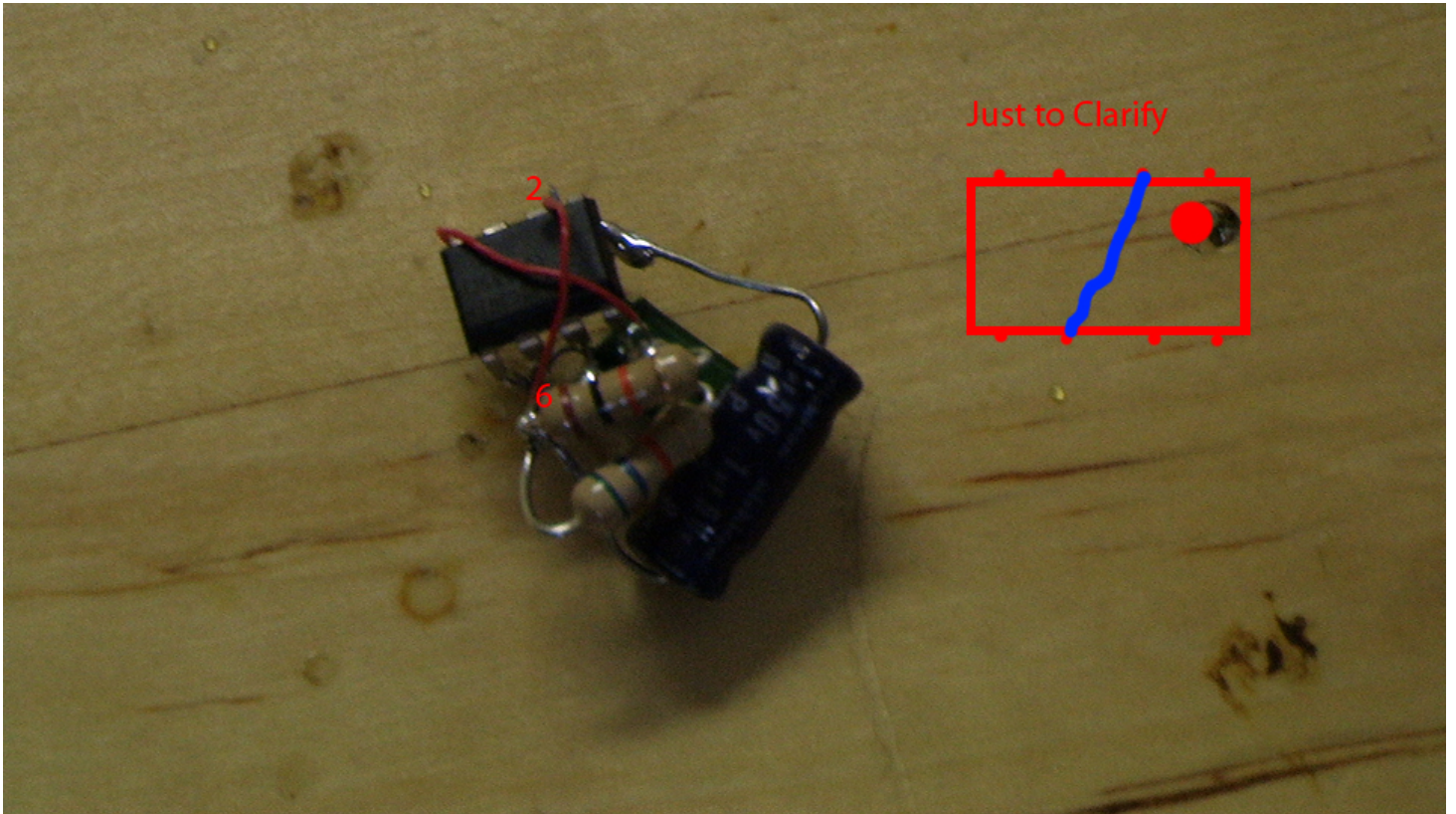

Step 7) Connect the Transistor Base (center pin usually) to 3 and bend other two prongs forward

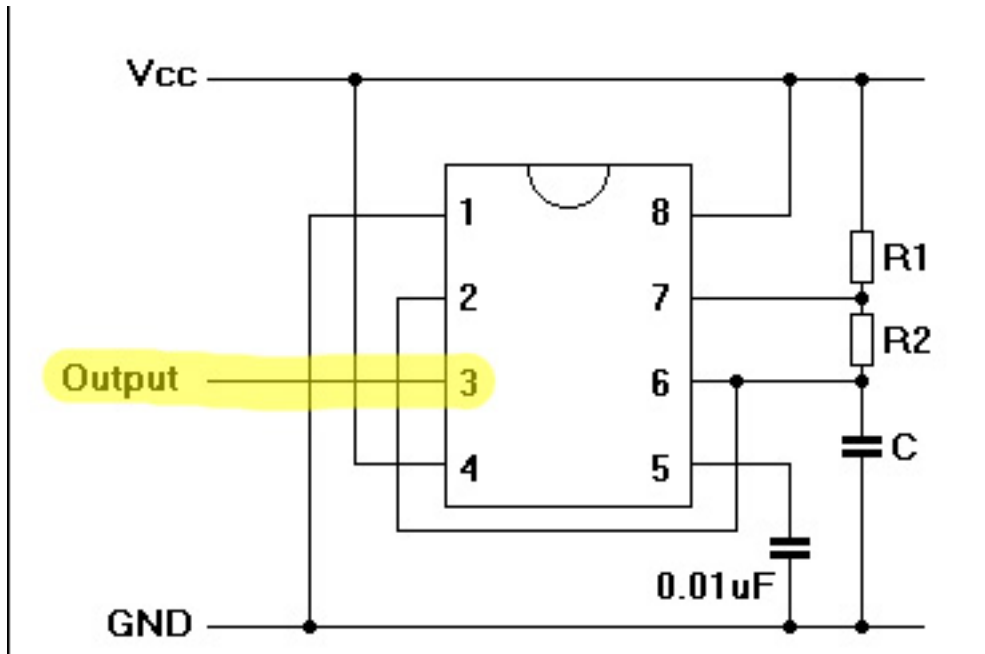
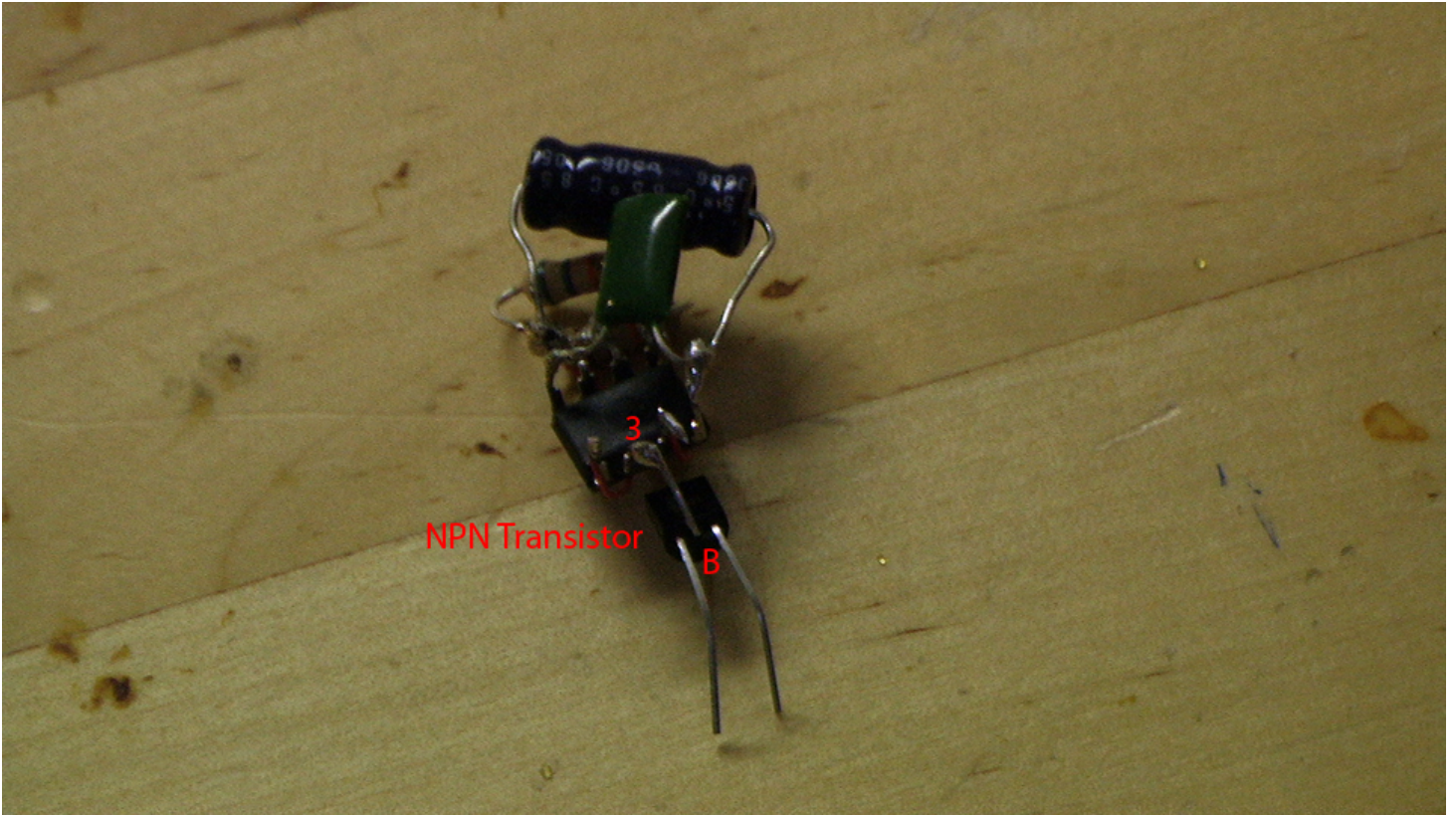

Step 8) Attach a wire to Point 1 and another one to Point 2

WARNING: Place a piece of tape on top of the chip next to the points. If you decide not too and accidentally get solder on the chip, your controller will be permanently ruined.

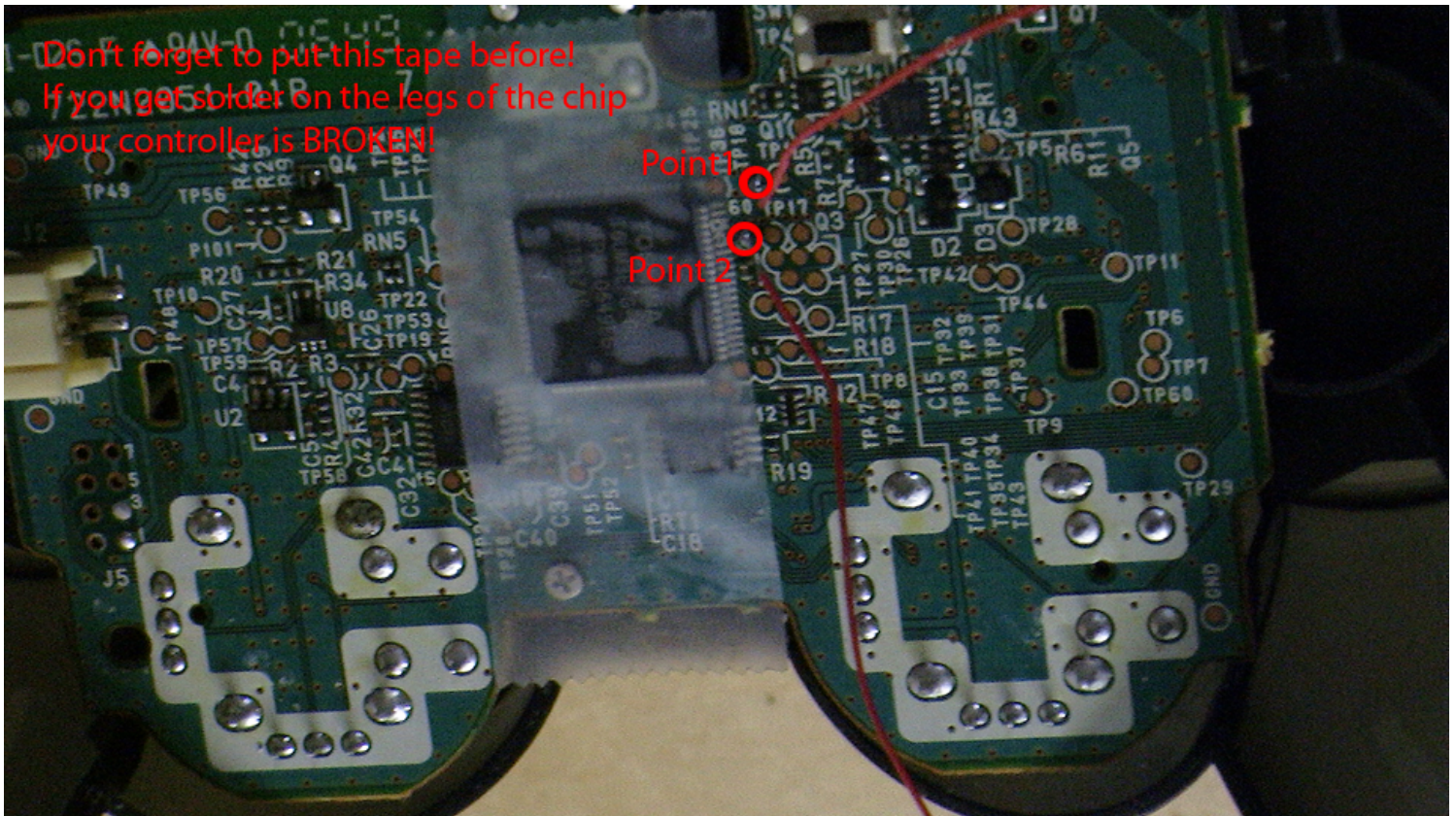

Dualshock3

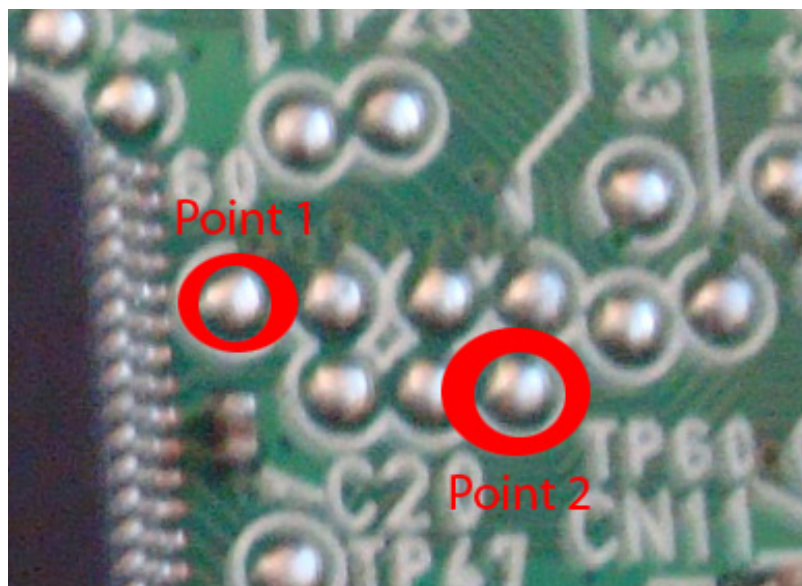

Step 9) Connect a wire to the ground(-) of the battery and connect a switch to the positive(+) of the battery (+-----switch-----).

WARNING: Be careful not to connect the + and - of the battery with solder. If you do, carefully attempt to remove excess solder.

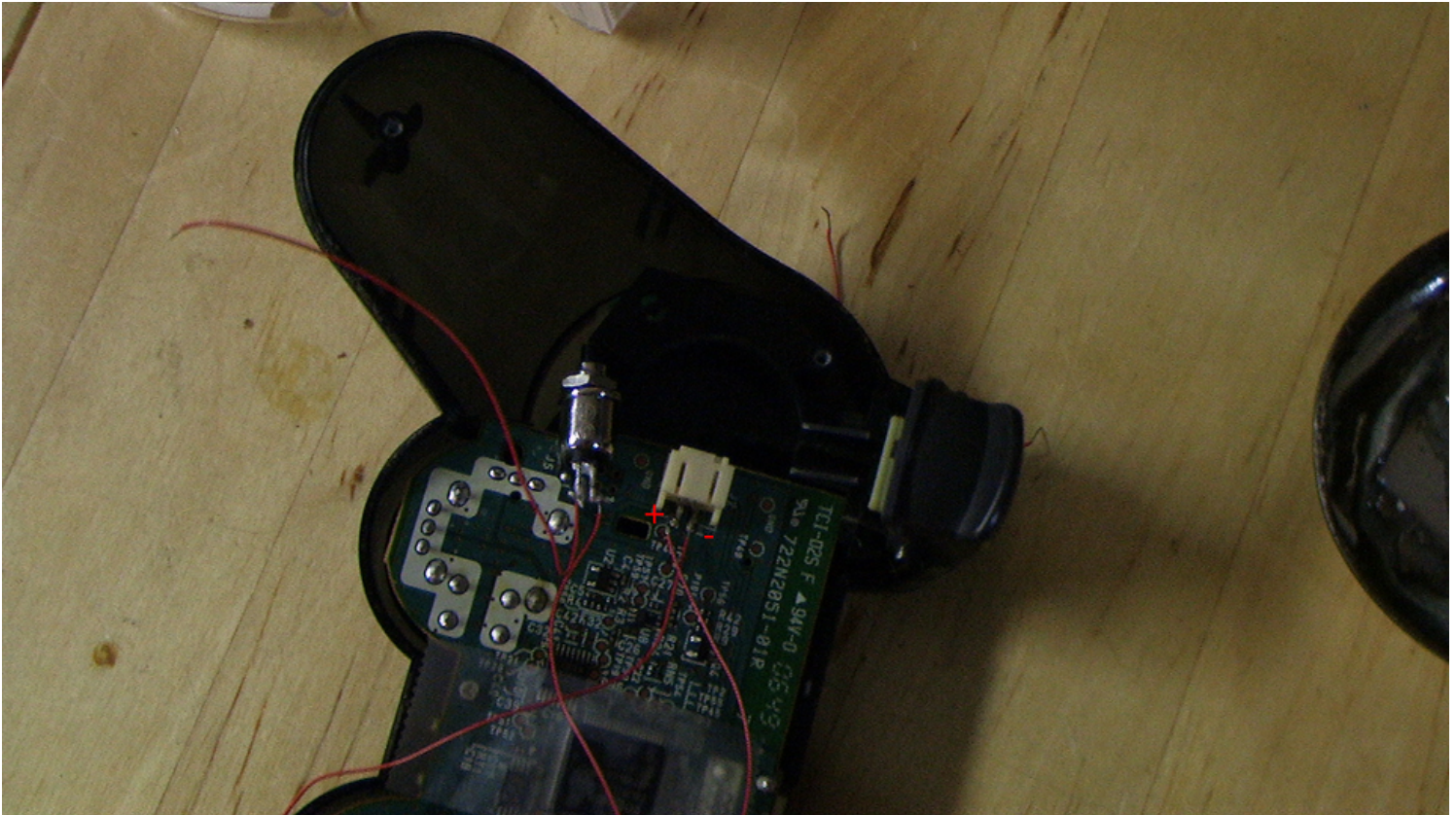

Step 10) Connect Point 1 and Point 2 to the remaining two legs of the transistor

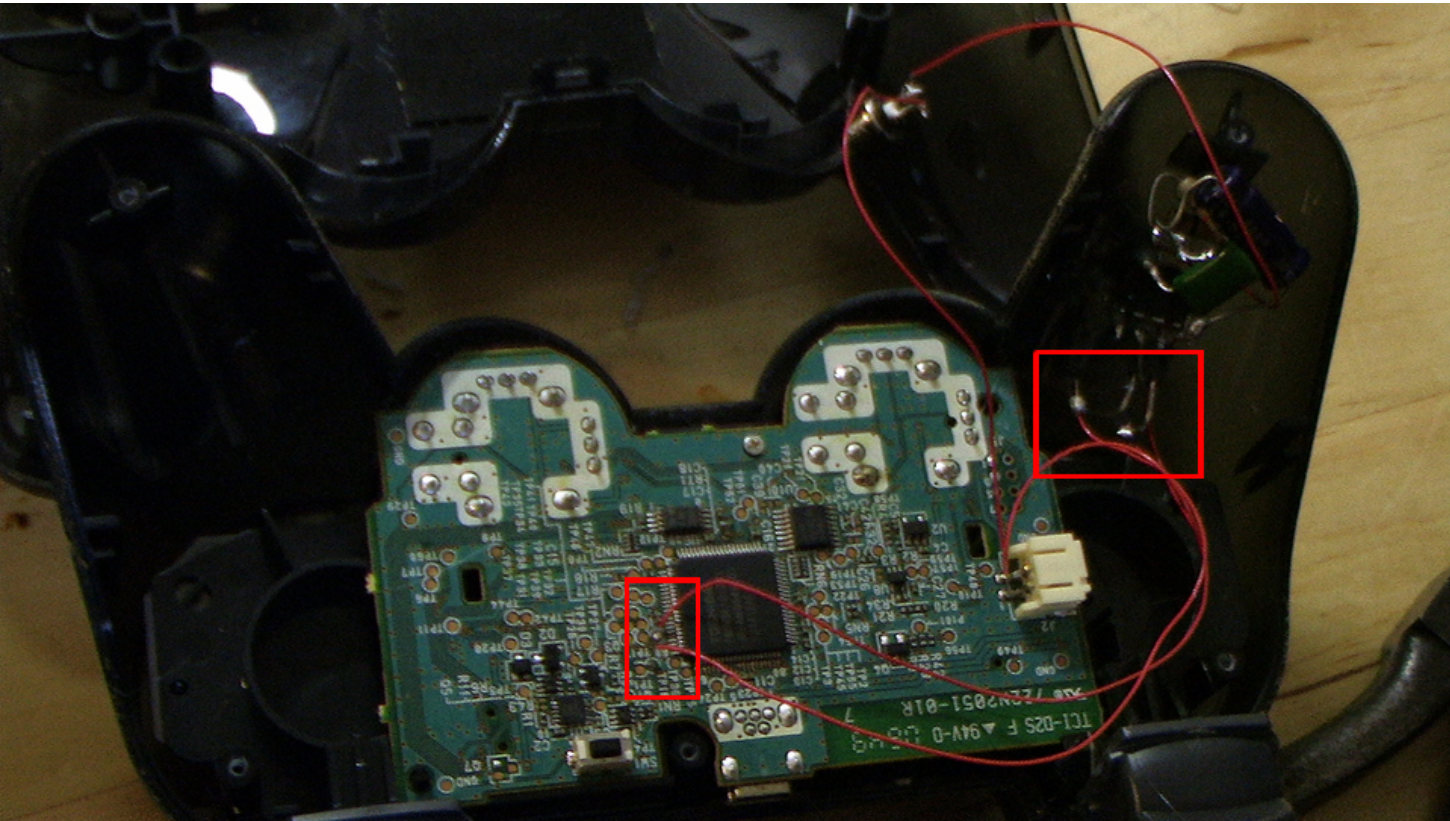

Step 11) Connect the + of the battery with the switch to 8 on the timer and the - of the battery to 1 of the timer

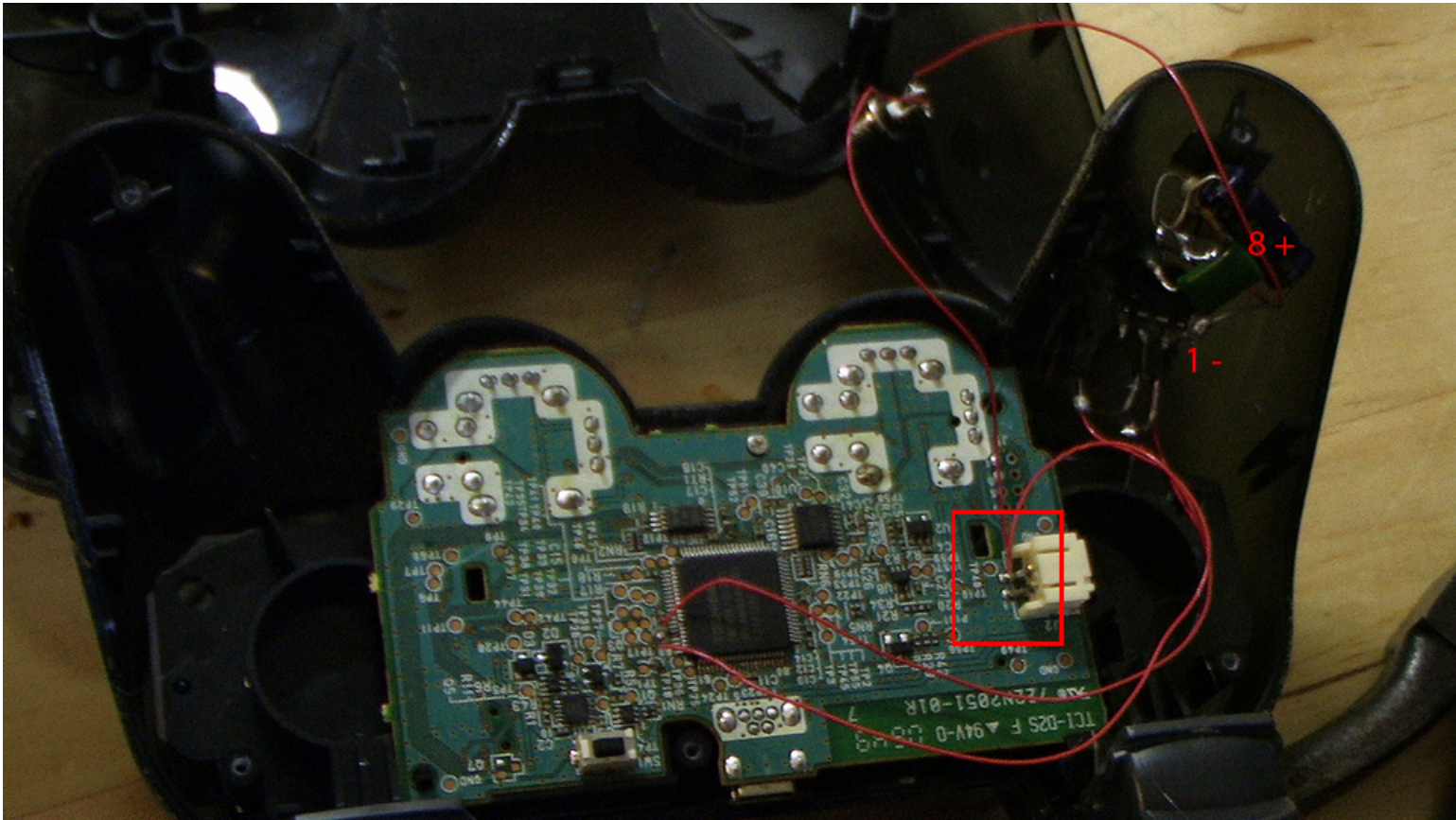

Step 12) Drill a hole in the controller for the button and insert it in

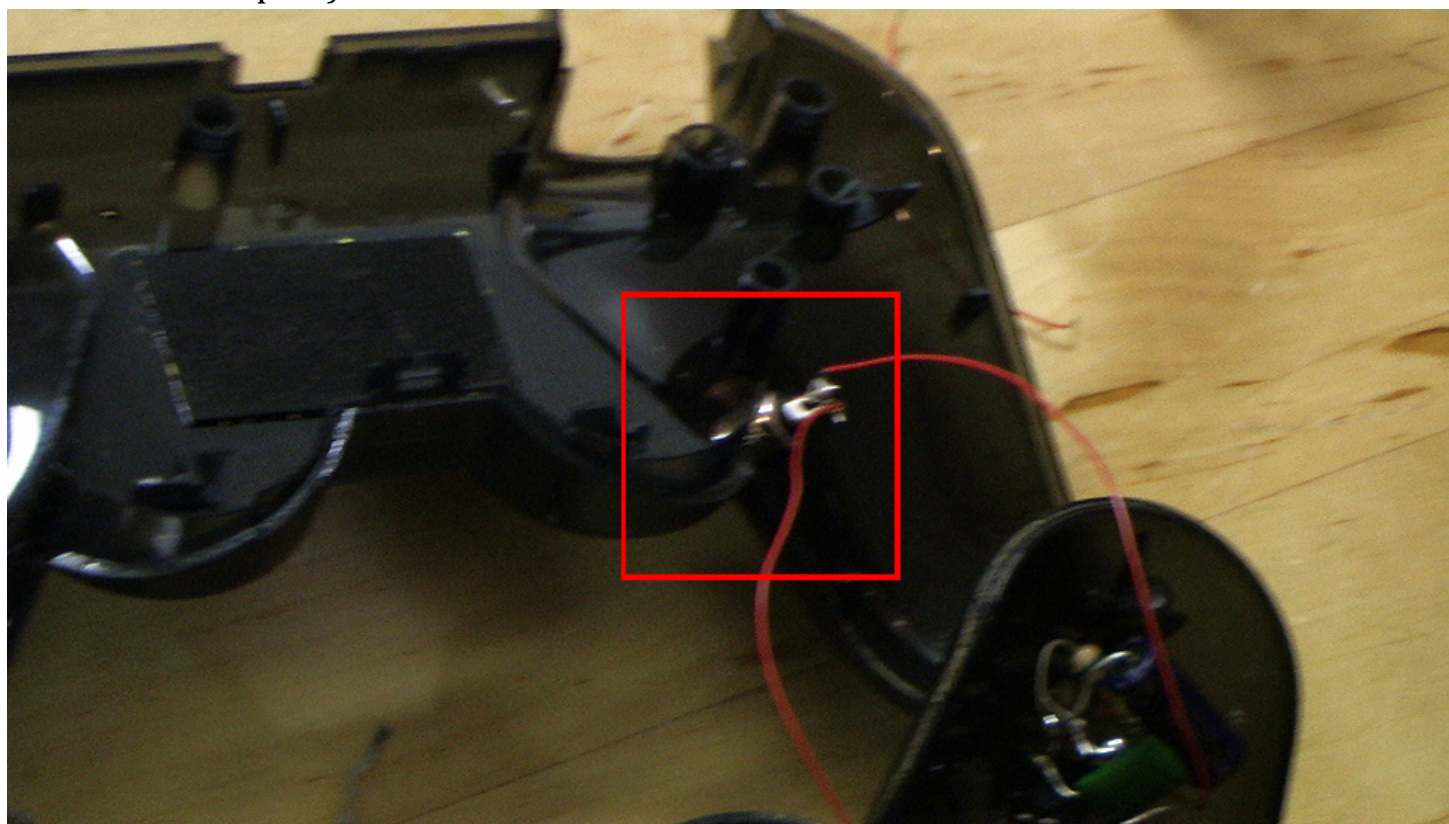

Step 13) (Ironically enough) Test your controller while it is still not put together. Hopefully everything should work. If not, make sure all the correct connections are made and make sure you followed everything CAREFULLY!

Here is the video of me testing the controller directly after what you saw in the pictures:

<http://www.youtube.com/watch?v=e2G883V4VfA>

Step 14) Bend everything connected to the timer to be as small as possible without making any unwanted connections. Be careful not to break any connections either. (I recommend testing it quickly again)

If you have a Dualshock3 you may need to remove the right side vibration motor (unless your confident you can fit everything without removing it which is unlikely). Otherwise just place all the electronics in the right handle.

Step 15) Put it all back together and test it one more time.

Here's the video of me testing it after everything was put back together:

<http://www.youtube.com/watch?v=lQ3Ut14lThU>

If everything tested correctly then:

Congratulations! You have a new Rapid Fire Controller!

Credits:

GBlaster – Creator

SykoXhitman – Photography

xXNasticoNXx (Xbox 360) – Assisting in development process

Mr. Eld0r – Promised he'd be in the credits

And of course all the people that supported me!